

Mar/17/20

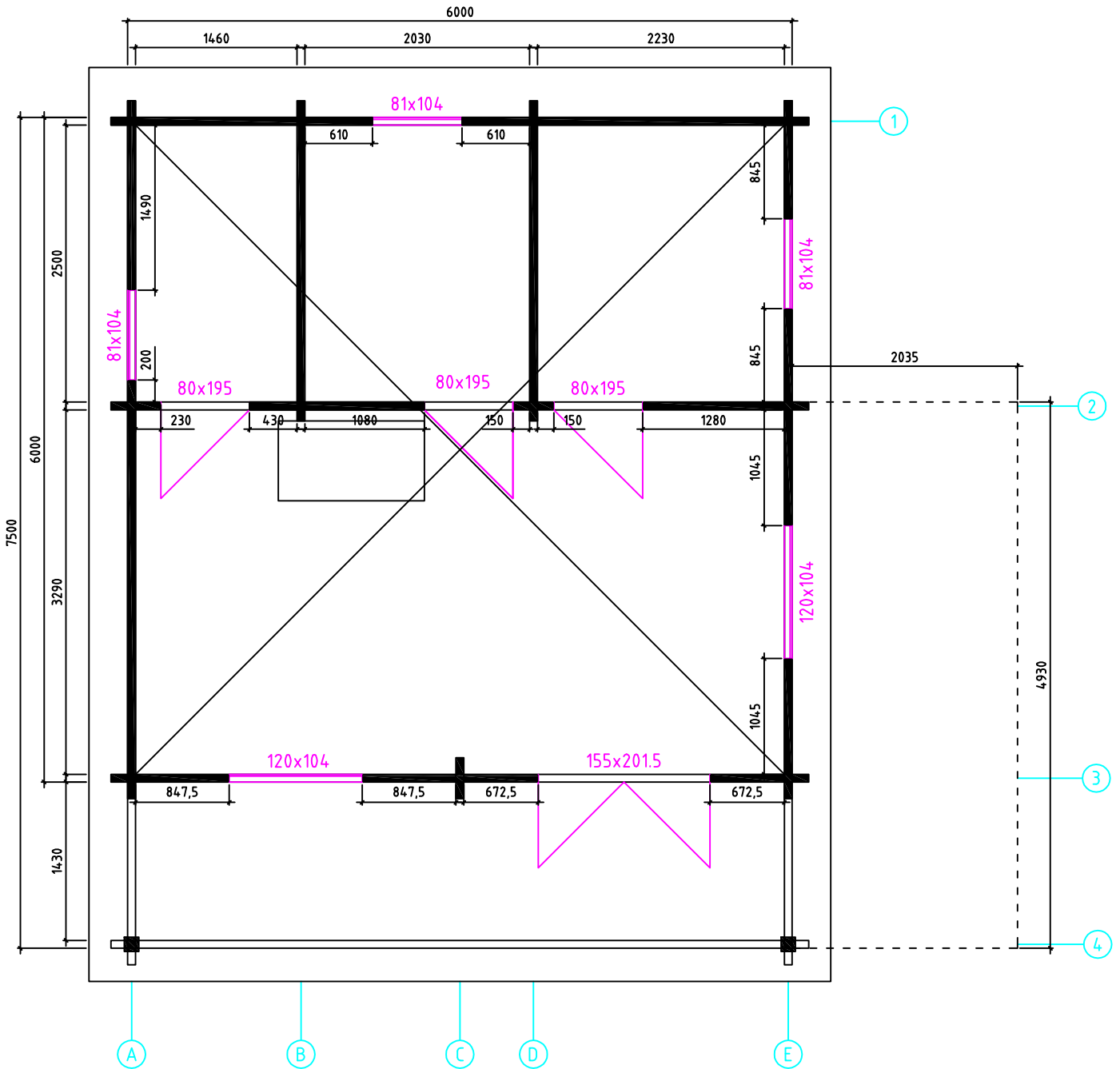

Mari //70/20
 Grundplan

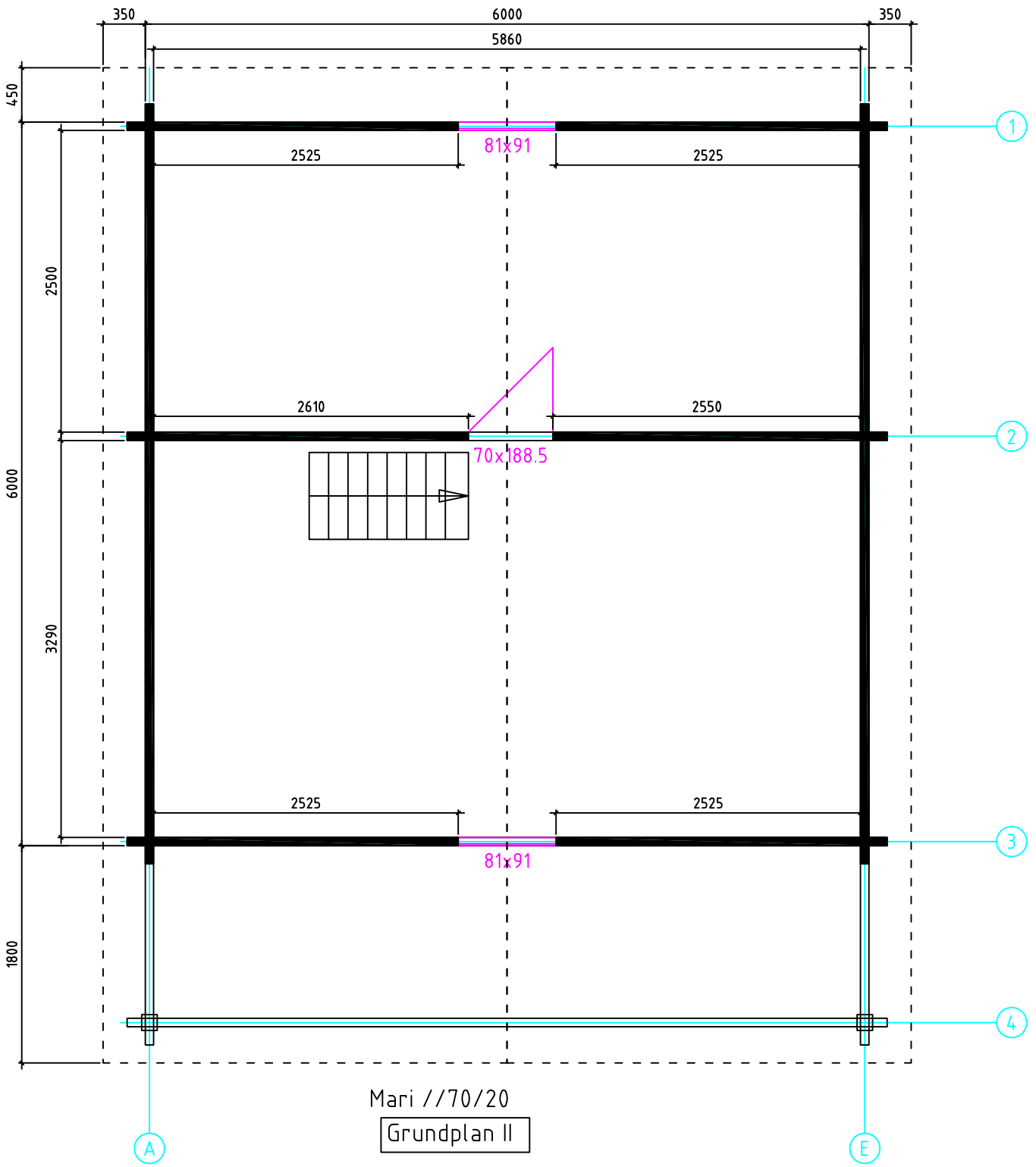

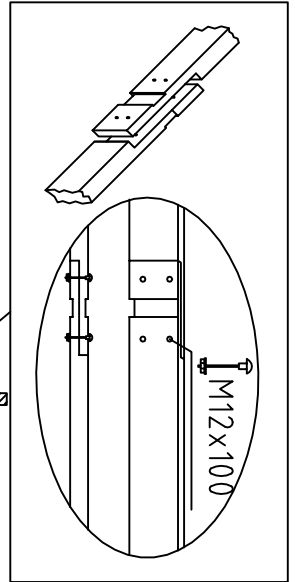
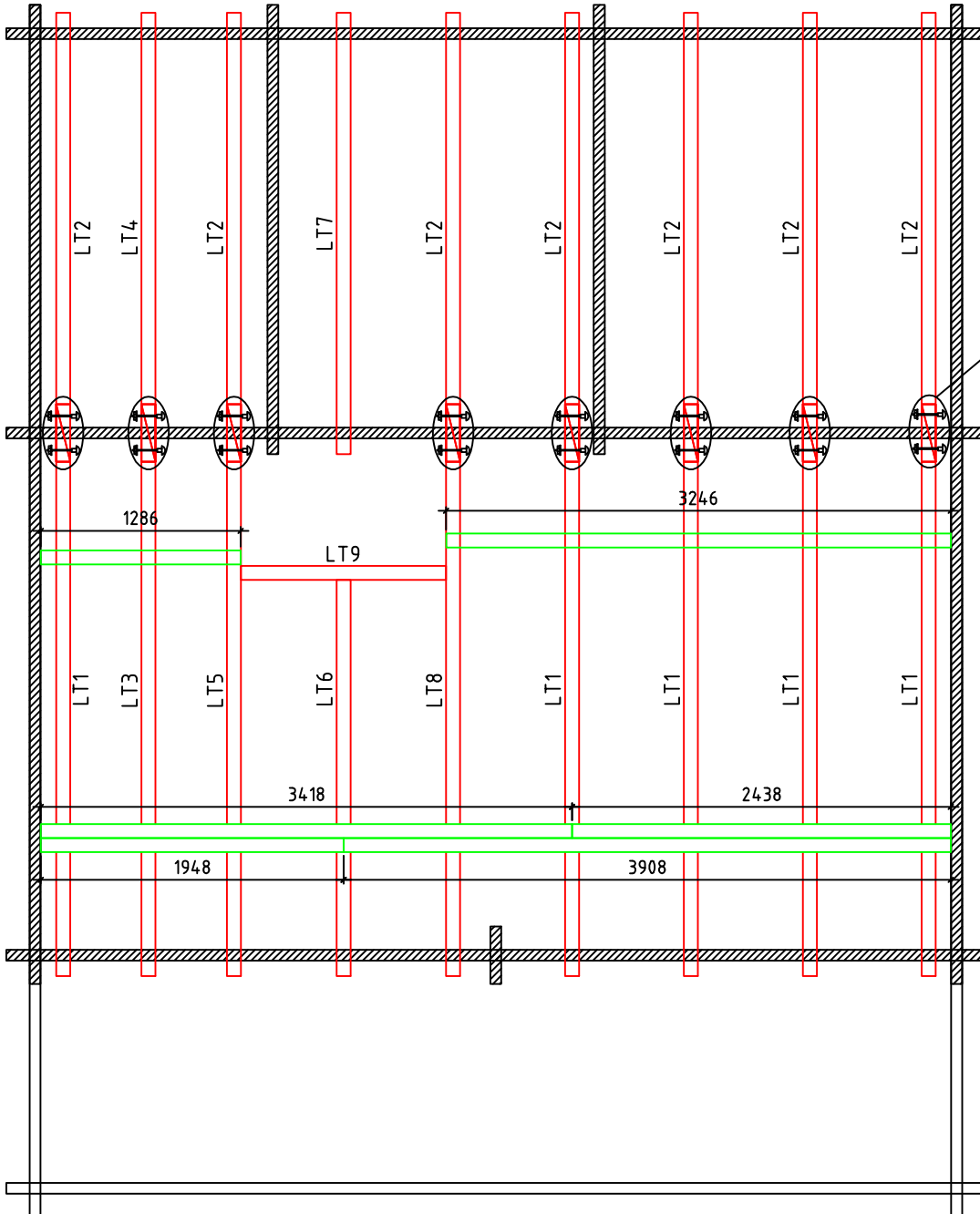

Mari //70/20

Deckenbalken

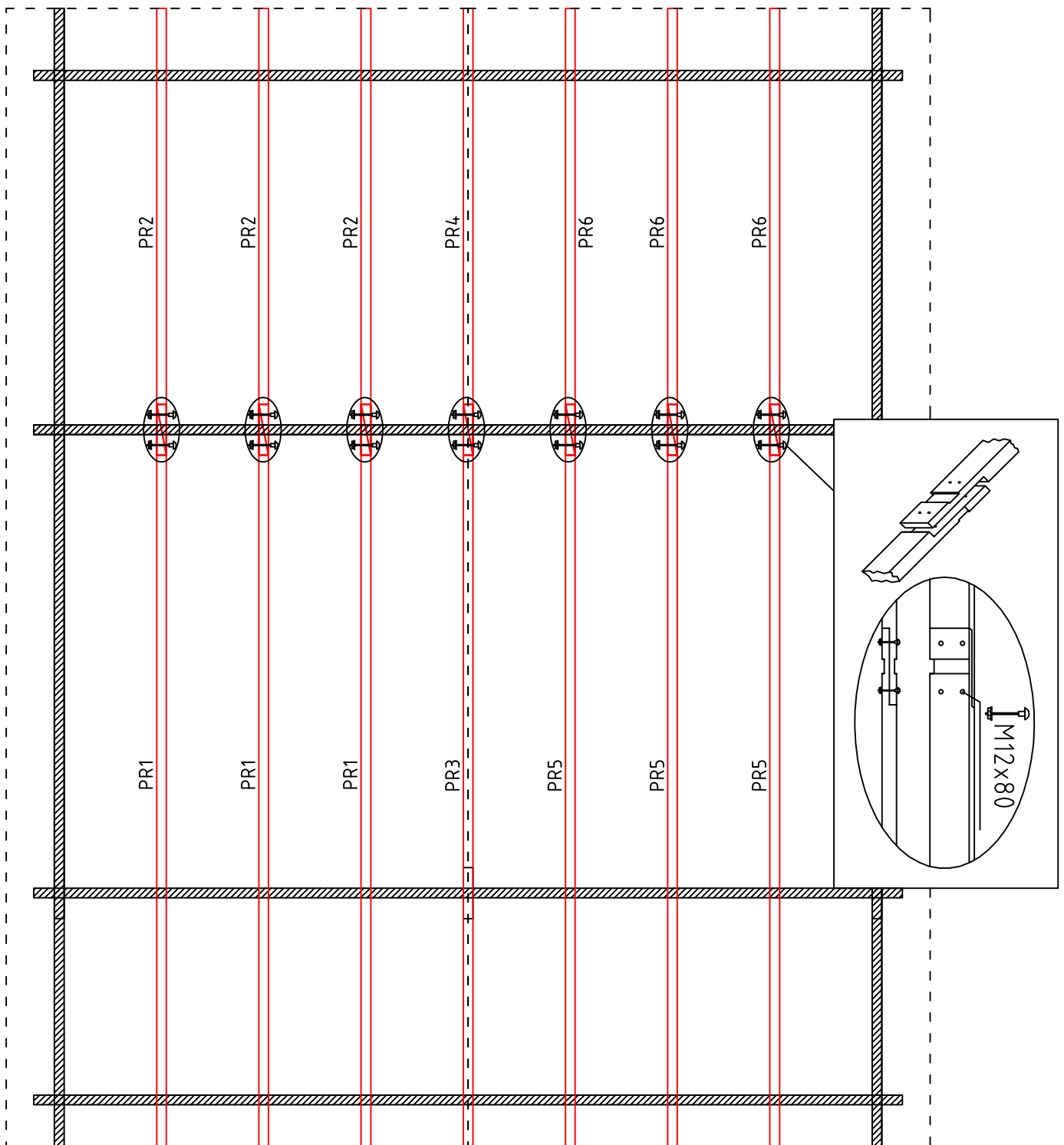

Mari //70/20
 Dachbalken

Wand 1

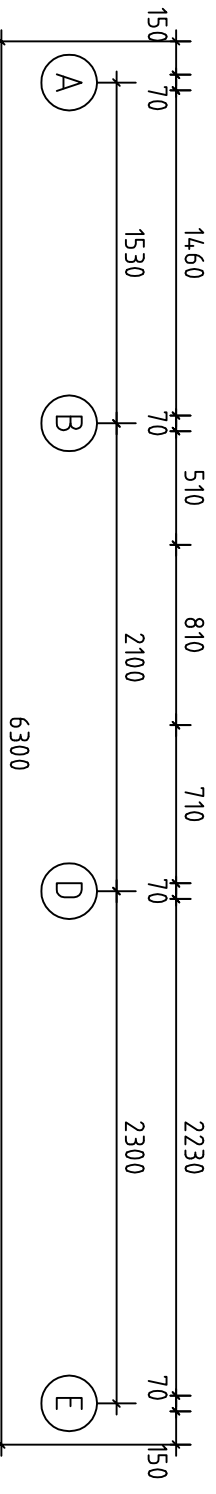
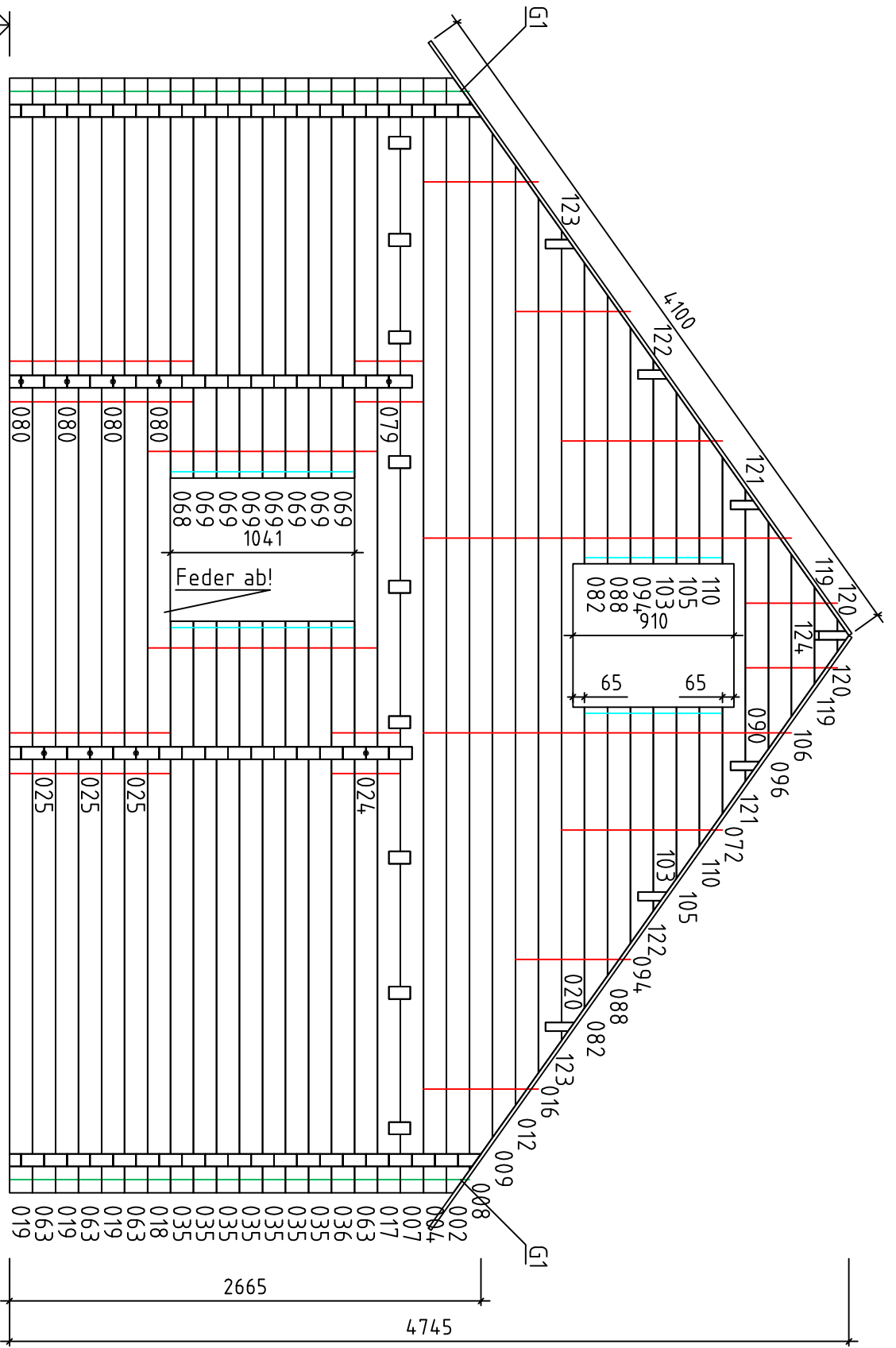

Mari // 70/20

Wand 4

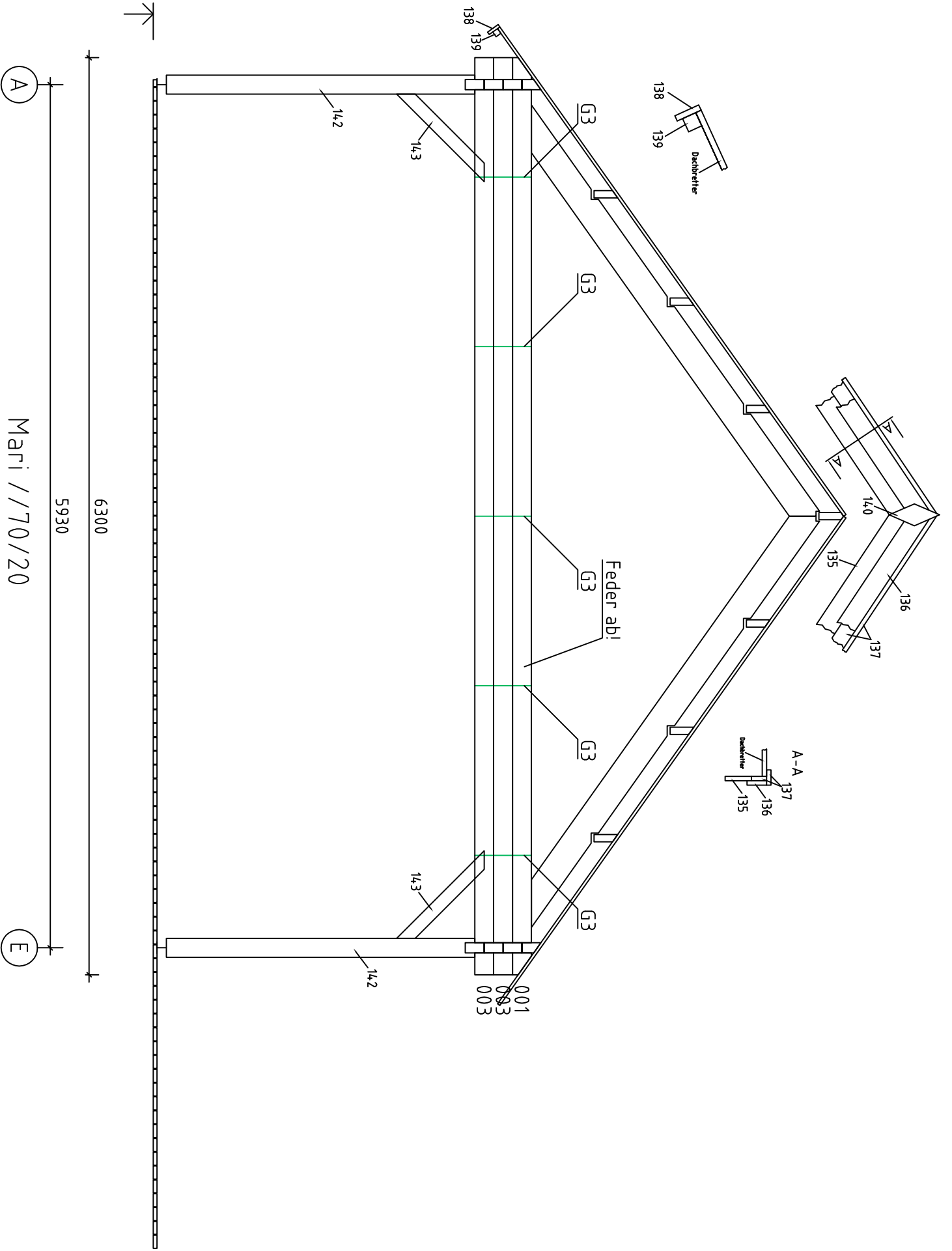

Wand E ↗

G2

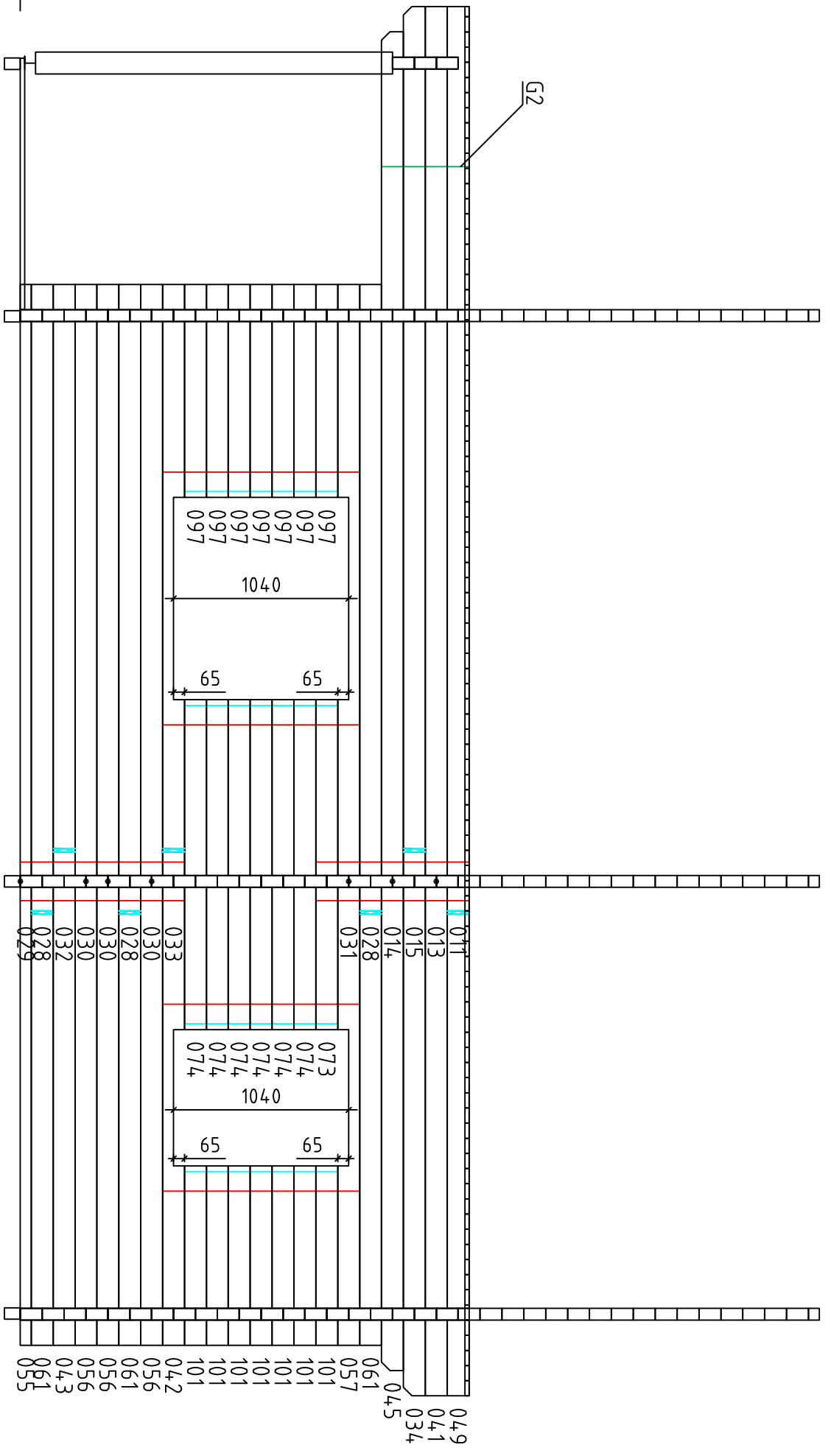

4

3

2

1

1500

150

70

1045

1200

3360

1045

70

845

2570

845

70

150

097
097
097
097
097

1040

65

65

011
013
015
014
028
031

073
074
074
074



1040

65



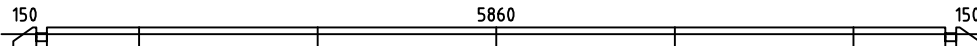
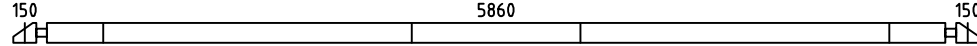
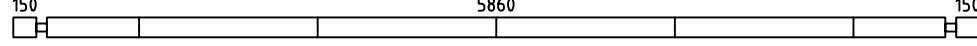
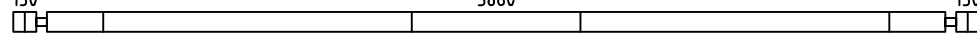
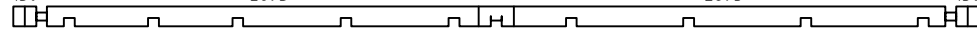
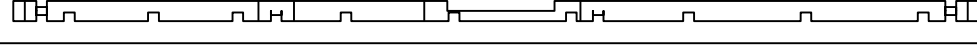
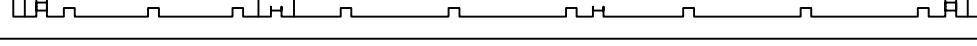
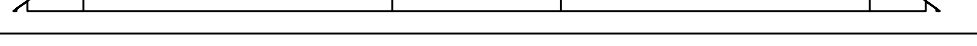
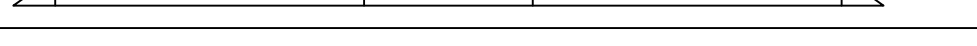
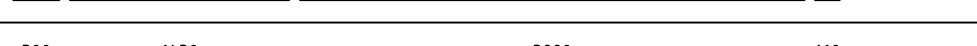
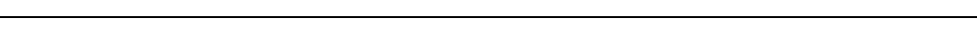
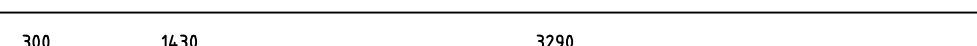
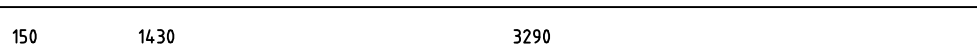
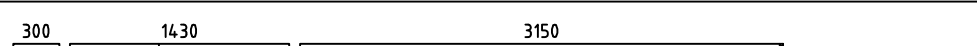
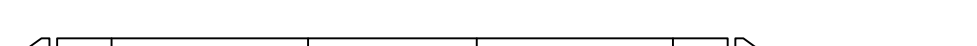
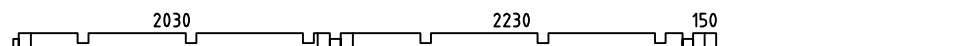
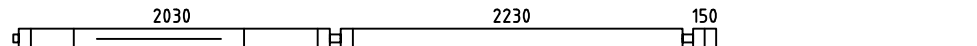
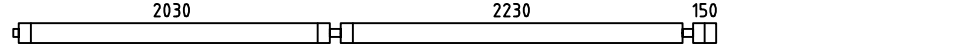
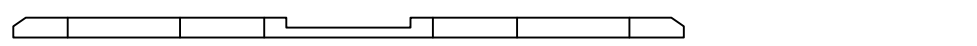
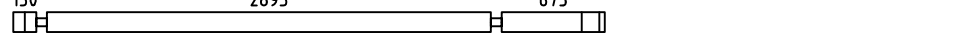
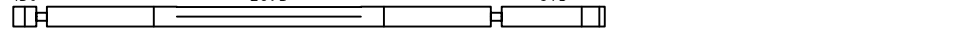
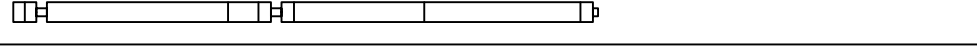
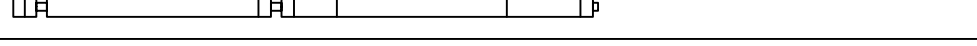
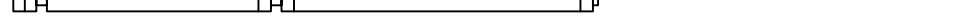

65



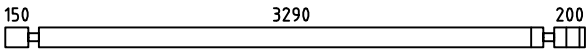
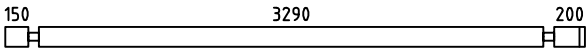
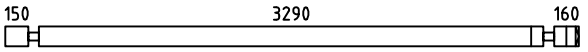
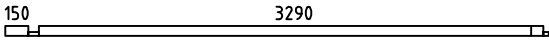
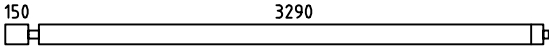
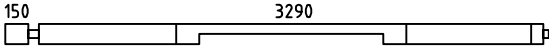
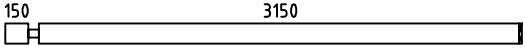
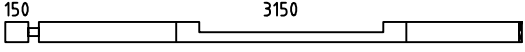
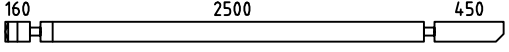
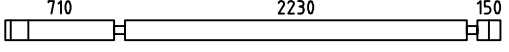
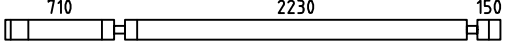
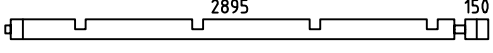
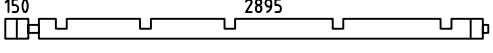
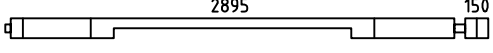
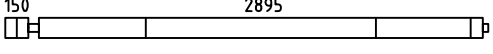
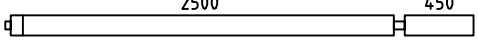
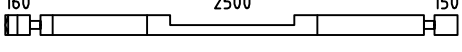
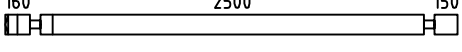
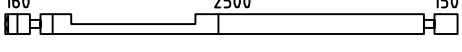
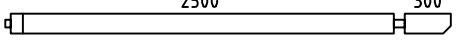
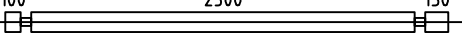
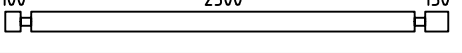
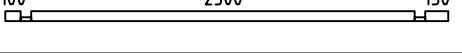
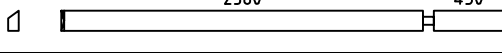
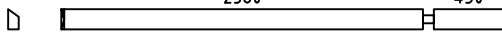

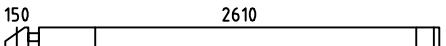
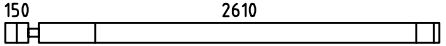
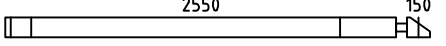
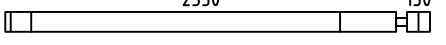
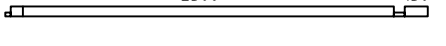
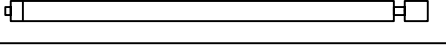
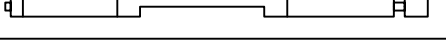
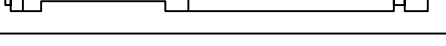
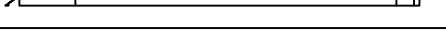
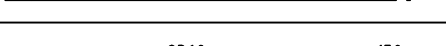
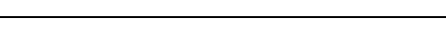
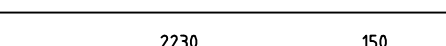
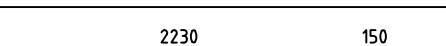
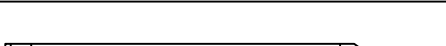

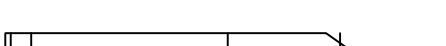
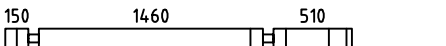
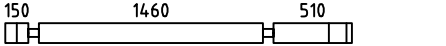
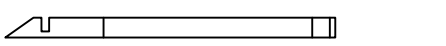
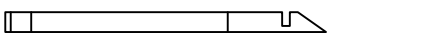
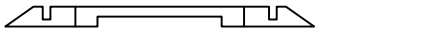
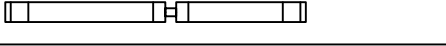
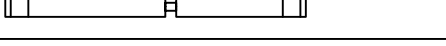
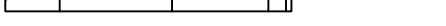
049
041
034
045
061
057
101
101
101
101
101
101
101
101
042
056
061
056
056
043
055



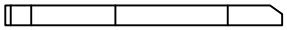
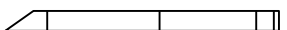
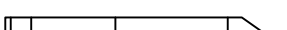
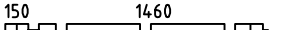
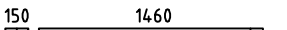
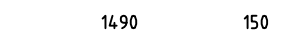

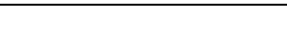
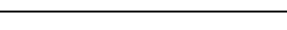
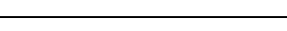
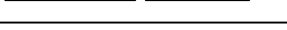
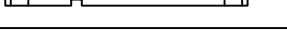
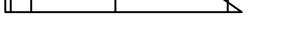
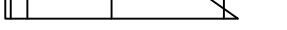
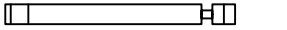
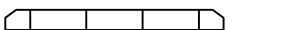
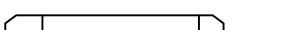
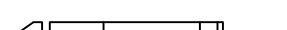
Mari // 70 / 20

| Pos | Mari //70/20 | ST | F (mm) | L (mm) |
|-----|--|----|--------|--------|
| 001 |  | 1 | 70x129 | 6300 |
| 002 |  | 2 | 70x130 | 6300 |
| 003 |  | 2 | 70x130 | 6300 |
| 004 |  | 2 | 70x130 | 6300 |
| 005 |  | 1 | 70x130 | 6300 |
| 006 |  | 1 | 70x130 | 6300 |
| 007 |  | 1 | 70x130 | 6300 |
| 008 |  | 2 | 70x130 | 6043 |
| 009 |  | 2 | 70x130 | 5677 |
| 010 |  | 1 | 70x130 | 5390 |
| 011 |  | 1 | 70x130 | 5390 |
| 012 |  | 2 | 70x130 | 5311 |
| 013 |  | 2 | 70x130 | 5195 |
| 014 |  | 2 | 70x130 | 5045 |
| 015 |  | 2 | 70x130 | 5020 |
| 016 |  | 2 | 70x130 | 4944 |
| 017 |  | 2 | 70x130 | 4585 |
| 018 |  | 1 | 70x130 | 4585 |
| 019 |  | 3 | 70x130 | 4585 |
| 020 |  | 2 | 70x130 | 4373 |
| 021 |  | 6 | 70x130 | 3858 |
| 022 |  | 1 | 70x130 | 3858 |
| 023 |  | 1 | 70x130 | 3815 |
| 024 |  | 1 | 70x130 | 3815 |
| 025 |  | 3 | 70x130 | 3815 |

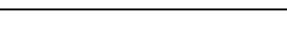
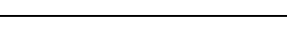
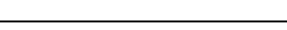
| Pos | Mari //70/20 | ST | F (mm) | L (mm) |
|-----|---|----|--------|--------|
| 026 |  | 1 | 70x130 | 3780 |
| 027 |  | 6 | 70x130 | 3780 |
| 028 |  | 6 | 70x130 | 3740 |
| 029 |  | 2 | 70x65 | 3545 |
| 030 |  | 7 | 70x130 | 3545 |
| 031 |  | 1 | 70x130 | 3545 |
| 032 |  | 3 | 70x130 | 3370 |
| 033 |  | 1 | 70x130 | 3370 |
| 034 |  | 2 | 70x130 | 3250 |
| 035 |  | 7 | 70x130 | 3230 |
| 036 |  | 1 | 70x130 | 3230 |
| 037 |  | 1 | 70x130 | 3150 |
| 038 |  | 1 | 70x130 | 3150 |
| 039 |  | 1 | 70x130 | 3150 |
| 040 |  | 1 | 70x130 | 3150 |
| 041 |  | 2 | 70x130 | 3055 |
| 042 |  | 1 | 70x130 | 2950 |
| 043 |  | 2 | 70x130 | 2950 |
| 044 |  | 1 | 70x130 | 2950 |
| 045 |  | 2 | 70x130 | 2905 |
| 046 |  | 2 | 70x129 | 2890 |
| 047 |  | 32 | 70x130 | 2890 |
| 048 |  | 2 | 70x65 | 2890 |
| 049 |  | 1 | 70x130 | 2880 |
| 050 |  | 1 | 70x130 | 2880 |

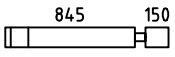
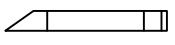
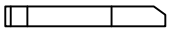
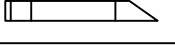
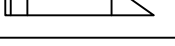
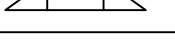
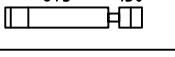
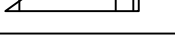
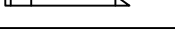
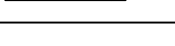
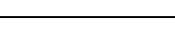
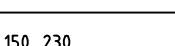
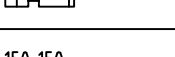
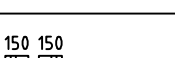
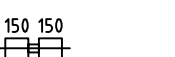
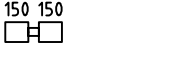
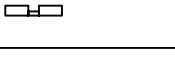
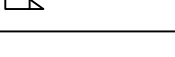
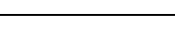
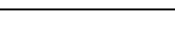
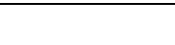
| Pos | Mari //70/20 | ST | F (mm) | L (mm) |
|-----|---|----|--------|--------|
| 051 |  | 1 | 70x130 | 2830 |
| 052 |  | 1 | 70x130 | 2830 |
| 053 |  | 1 | 70x130 | 2770 |
| 054 |  | 1 | 70x130 | 2770 |
| 055 |  | 2 | 70x65 | 2755 |
| 056 |  | 6 | 70x130 | 2755 |
| 057 |  | 1 | 70x130 | 2755 |
| 058 |  | 1 | 70x130 | 2755 |
| 059 |  | 1 | 70x130 | 2702 |
| 060 |  | 1 | 70x130 | 2642 |
| 061 |  | 6 | 70x130 | 2580 |
| 062 |  | 1 | 70x130 | 2518 |
| 063 |  | 4 | 70x130 | 2485 |
| 064 |  | 1 | 70x130 | 2485 |
| 065 |  | 1 | 70x130 | 2458 |
| 066 |  | 1 | 70x130 | 2335 |
| 067 |  | 1 | 70x130 | 2275 |
| 068 |  | 1 | 70x130 | 2260 |
| 069 |  | 7 | 70x130 | 2260 |
| 070 |  | 1 | 70x130 | 2152 |
| 071 |  | 1 | 70x130 | 2092 |
| 072 |  | 2 | 70x130 | 2014 |
| 073 |  | 1 | 70x130 | 1960 |
| 074 |  | 6 | 70x130 | 1960 |
| 075 |  | 1 | 70x130 | 1867 |

| Pos | Mari //70/20 | ST | F (mm) | L (mm) |
|-----|---|----|--------|--------|
| 076 |  | 1 | 70x130 | 1807 |
| 077 |  | 1 | 70x130 | 1786 |
| 078 |  | 1 | 70x130 | 1726 |
| 079 |  | 2 | 70x130 | 1715 |
| 080 |  | 4 | 70x130 | 1715 |
| 081 |  | 7 | 70x130 | 1710 |
| 082 |  | 4 | 70x130 | 1701 |
| 083 |  | 1 | 70x130 | 1603 |
| 084 |  | 7 | 70x130 | 1590 |
| 085 |  | 1 | 70x130 | 1590 |
| 086 |  | 15 | 70x130 | 1580 |
| 087 |  | 1 | 70x130 | 1543 |
| 088 |  | 4 | 70x130 | 1518 |
| 089 |  | 15 | 70x130 | 1500 |
| 090 |  | 2 | 70x130 | 1424 |
| 091 |  | 1 | 70x130 | 1424 |
| 092 |  | 1 | 70x130 | 1420 |
| 093 |  | 1 | 70x130 | 1360 |
| 094 |  | 4 | 70x130 | 1335 |
| 095 |  | 1 | 70x130 | 1282 |
| 096 |  | 2 | 70x130 | 1282 |
| 097 |  | 7 | 70x130 | 1265 |
| 098 |  | 1 | 70x130 | 1129 |
| 099 |  | 1 | 70x130 | 1069 |
| 100 |  | 8 | 70x130 | 1068 |

| Pos | Mari //70/20 | ST | F (mm) | L (mm) |
|-----|---|----|--------|--------|
| 101 |  | 7 | 70x130 | 1065 |
| 102 |  | 1 | 70x130 | 1053 |
| 103 |  | 4 | 70x130 | 1044 |
| 104 |  | 1 | 70x130 | 993 |
| 105 |  | 4 | 70x130 | 968 |
| 106 |  | 3 | 70x130 | 916 |
| 107 |  | 15 | 70x130 | 893 |
| 108 |  | 1 | 70x130 | 870 |
| 109 |  | 1 | 70x130 | 810 |
| 110 |  | 4 | 70x130 | 785 |
| 111 |  | 1 | 70x130 | 687 |
| 112 |  | 1 | 70x130 | 627 |
| 113 |  | 15 | 70x130 | 450 |
| 114 |  | 14 | 70x130 | 370 |
| 115 |  | 1 | 70x130 | 370 |
| 116 |  | 1 | 70x129 | 370 |
| 117 |  | 16 | 70x130 | 370 |
| 118 |  | 1 | 70x65 | 370 |
| 119 |  | 6 | 70x130 | 250 |
| 120 |  | 6 | 70x47 | 67 |
| 121 |  | 6 | 70x44 | 62 |
| 122 |  | 6 | 70x40 | 57 |
| 123 |  | 6 | 70x37 | 52 |
| 124 |  | 3 | 70x25 | 50 |
| | | | | |

| Pos | Mari //70/20 | ST | F (mm) | L (mm) |
|------|--------------|----|--------|--------|
| LT8 | | 1 | 90x140 | 3680 |
| LT5 | | 1 | 90x140 | 3680 |
| LT3 | | 1 | 90x140 | 3680 |
| LT1 | | 5 | 90x140 | 3680 |
| LT2 | | 7 | 90x140 | 2890 |
| LT4 | | 1 | 90x140 | 2890 |
| LT7 | | 1 | 90x140 | 2840 |
| LT6 | | 1 | 90x140 | 2550 |
| LT9 | | 1 | 90x140 | 1320 |
| | | | | |
| AR5 | Impr. | 4 | 68x94 | 5990 |
| AR4 | Impr. | 1 | 68x94 | 4784 |
| AR2 | Impr. | 3 | 68x94 | 3288 |
| AR3 | Impr. | 4 | 68x94 | 2498 |
| AR9 | Impr. | 2 | 68x94 | 2035 |
| AR12 | Impr. | 1 | 68x94 | 1967 |
| AR1 | Impr. | 3 | 68x94 | 1432 |
| AR10 | Impr. | 22 | 44x94 | 2893 |
| AR8 | Impr. | 5 | 44x94 | 2228 |
| AR7 | Impr. | 5 | 44x94 | 2032 |
| AR11 | Impr. | 11 | 44x94 | 1967 |
| AR6 | Impr. | 5 | 44x94 | 1458 |
| | | | | |
| | | | | |
| | | | | |

| Pos | Mari //70/20 | | ST | F (mm) | L (mm) |
|-----|--------------------|------------|-----|-----------|-----------|
| PR1 | | Dachbalken | 3 | 70x190 | 5380 |
| PR3 | | Dachbalken | 1 | 70x190 | 5380 |
| PR5 | | Dachbalken | 3 | 70x190 | 5380 |
| PR6 | | Dachbalken | 3 | 70x190 | 3240 |
| PR2 | | Dachbalken | 3 | 70x190 | 3240 |
| PR4 | | Dachbalken | 1 | 70x190 | 3240 |
| | | | | | |
| SA1 | | Sparren | 2 | 70x190 | 3463 |
| | | | | | |
| 130 | Fussbodenbretter | | 66 | 90x26 | 3286 |
| | | | 65 | 90x26 | 2496 |
| 131 | Terrassenbretter | Impr. | 22 | 90x26 | 4924 |
| | | | 63 | 90x26 | 1493 |
| 132 | Schlafbodenbretter | | 7 | 90x26 | 3246 |
| | | | 7 | 90x26 | 1286 |
| | | | 29 | 90x26 | 1948 |
| | | | 29 | 90x26 | 3908 |
| | | | 29 | 90x26 | 3418 |
| | | | 29 | 90x26 | 2438 |
| 133 | Dachbretter | | 184 | 90x20 | 4100 |
| 134 | Abdeckleiste | | | 20x40 | 200lfm |
| 135 | Giebelbretter | | 4 | 20x120 | 4300 |
| 136 | Giebelbretter | | 4 | 20x90 | 4300 |
| 137 | Giebeldeckbretter | | 8 | 20x70 | 4300 |
| 138 | Traufenbretter | | 4 | 20x90 | 4250 |

